

# **RIGOL**

## **User Guide**

### **PVA7000 Series Active Probe**

**Jan. 2022**

**RIGOL TECHNOLOGIES CO., LTD.**



# Guaranty and Declaration

## Copyright

© 2022 **RIGOL** TECHNOLOGIES CO., LTD. All Rights Reserved.

## Trademark Information

**RIGOL**® is the trademark of **RIGOL**.

## Publication Number

UGE31102-1110

## Notices

- **RIGOL** products are covered by P.R.C. and foreign patents, issued and pending.
- **RIGOL** reserves the right to modify or change parts of or all the specifications and pricing policies at the company's sole decision.
- Information in this publication replaces all previously released materials.
- Information in this publication is subject to change without notice.
- **RIGOL** shall not be liable for either incidental or consequential losses in connection with the furnishing, use, or performance of this manual, as well as any information contained.
- Any part of this document is forbidden to be copied, photocopied, or rearranged without prior written approval of **RIGOL**.

## Product Certification

**RIGOL** guarantees that this product conforms to the national and industrial standards in China as well as the ISO9001:2015 standard and the ISO14001:2015 standard. Other international standard conformance certifications are in progress.

## Contact Us

If you have any problem or requirement when using our products or this manual, please contact **RIGOL**.

E-mail: [service@rigol.com](mailto:service@rigol.com)

Website: [www.rigol.com](http://www.rigol.com)

# Safety Notices and Symbols

## Safety Notices in this Manual:



---

### **WARNING**

Indicates a potentially hazardous situation or practice which, if not avoided, will result in serious injury or death.

---



---

### **CAUTION**

Indicates a potentially hazardous situation or practice which, if not avoided, could result in damage to the product or loss of important data.

---

## Safety Terms on the Product:

**DANGER** It calls attention to an operation, if not correctly performed, could result in injury or hazard immediately.

**WARNING** It calls attention to an operation, if not correctly performed, could result in potential injury or hazard.

**CAUTION** It calls attention to an operation, if not correctly performed, could result in damage to the product or other devices connected to the product.

## Safety Symbols on the Product:



Hazardous  
Voltage



Safety  
Warning



Protective  
Earth  
Terminal



Chassis  
Ground



Test Ground

# Document Overview

This document is used to guide users to get a quick understanding of the PVA7000 series active probe as well as its using method. Besides, this document gives service information relating to general care and cleaning.

PVA7000 series active probe includes the following model.

Model	Bandwidth
PVA7250	>2.5GHz

Main topics:

- **PVA7000 Series Overview**  
This chapter gives a brief introduction of the probe, including general inspection, probe dimensions, standard accessories, and etc.
- **To Use PVA7000 Series Active Probe**  
This chapter introduces how to use the probe, including how to connect to the oscilloscope, how to use the probe head, how to replace probe accessories, how to adjust the offset voltage, how to calibrate the probe, and etc.
- **Care and Cleaning**
- **Warranty**
- **Specifications**

# Contents

- Guaranty and Declaration ..... I**
- Safety Notices and Symbols..... II**
- Document Overview..... III**
- PVA7000 Series Overview ..... 1**
  - Probe Introduction ..... 2
  - General Inspection ..... 3
  - Probe Dimensions..... 4
  - Accessories and Options..... 5
  - Active Probe Amplifier ..... 5
  - Probe Head..... 6
- To Use PVA7000 Series Active Probe..... 9**
  - To Connect to the Oscilloscope ..... 10
  - To Use the Probe Head ..... 12
  - To Replace Probe Accessories ..... 15
  - To Adjust Offset Voltage..... 16
  - To Calibrate the Probe..... 17
- Care and Cleaning ..... 18**
- Warranty ..... 19**
- Specifications ..... 20**

# PVA7000 Series Overview

This chapter guides users to quickly get familiar with the PVA7000 series active probe.

Main topics:

- Probe Introduction
- General Inspection
- Probe Dimensions
- Accessories and Options
- Active Probe Amplifier
- Probe Head

## **Probe Introduction**

PVA7000, with more than 2.5GHz bandwidth, is an active probe for high frequency application. It can be used to measure differential and single-ended signals with better common mode rejection. PVA7000 uses plug-on socket probe head and supports 3 types of interchangeable probe heads to optimize the performance and usability. Besides, its replaceable probe tip prolongs the service life of the probe and the probe tip spacing can be precisely adjusted to fit different test point spacings.

PVA7000 is compatible with the auto-identification port of **RIGOL** MSO/DS7000/MSO8000 series oscilloscope and can be recognized and configured automatically by this port. Its snap-in BNC connector enables easier connection with the oscilloscope.

PVA7000 provides various accessories and options, as well as multiple replaceable components which make it applicable to be used in different tests and measurements.



## General Inspection

### 1. **Inspect the packaging**

If the packaging has been damaged, do not dispose the damaged packaging or cushioning materials until the shipment has been checked for completeness and has passed both electrical and mechanical tests.

The consigner or carrier shall be liable for the damage to the instrument resulting from shipment. **RIGOL** would not be responsible for free maintenance/rework or replacement of the instrument.

### 2. **Inspect the instrument**

In case of any mechanical damage, missing parts, or failure in passing the electrical and mechanical tests, contact your **RIGOL** sales representative.

### 3. **Check the accessories**

Please check the accessories according to the packing lists. If the accessories are damaged or incomplete, please contact your **RIGOL** sales representative.

## Probe Dimensions

**Figure 1** shows the dimensions of the main parts of PVA7000 series active probe.

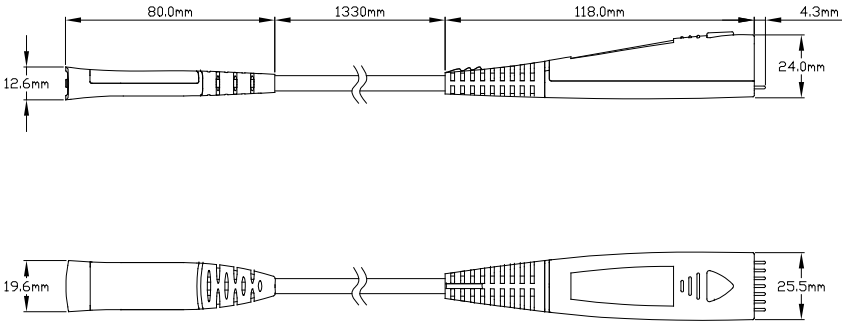

Figure 1 Probe Dimensions

## Accessories and Options

This section lists the probe kits, standard accessories of the PVA7000 series active probe respectively. All the components listed below can be ordered from **RIGOL**. PVA7250 Active Probe Kit contains all the accessories listed in **Table 1**. If any accessory or option needs to be ordered separately, please refer to **Table 1**.

Table 1 PVA7250 Active Probe Kit Standard Accessories

Name	Qty.
PVA7250 Active Probe Amplifier	1
Solder-in Differential Probe Head	1
Solder-in Single-ended Probe Head	1
Hand-held Differential Probe Head	1
0.2mm Nickel Wire	1
Trim Gauge	1
50Ω Probe Tip	8
Marker Rings (Yellow/Pink/Light Blue/Dark Blue)	8
User Guide	1
Probe Bag	1
Storage Box	1

**Note:** The accessories listed in this section are only for reference, the actual product is the standard.

## Active Probe Amplifier

The active probe amplifier (**Figure 2**), with more than 2.5GHz bandwidth, is a main component of the active probe. One end of the active probe amplifier can be connected to the MSO8000 series oscilloscope and the other end can be

connected to the desired probe head.

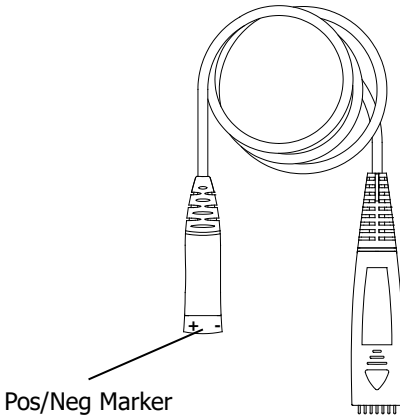

Figure 2 Active Probe Amplifier

When connecting a **probe head** to an **active probe amplifier**, push it straight in. For single-ended probe, when connecting them, pay attention to their polarities. If the polarity is reversed, the performance of the active probe would be undermined and the active probe might even be damaged.



---

**CAUTION**

There is a black mark sleeve on the negative pole of the solder-in single-ended probe head.

---

## Probe Head

PVA7000 supports **hand-held probe head** and **solder-in probe head**.

### 1. Hand-held Probe Head

The type of Hand-held probe head is: **hand-held differential probe head**.

Like using common passive probes, you can use this kind of probe head to easily measure signals. Besides, the spacing between the probe tips can be easily adjusted to fulfill your various measurement requirements.

For hand-held differential probe head, the spacing between the probe tips is controlled by the roller on the probe head. As shown in **Figure 3**, turning the roller forwards or backwards can precisely adjust the spacing between the two probe tips.

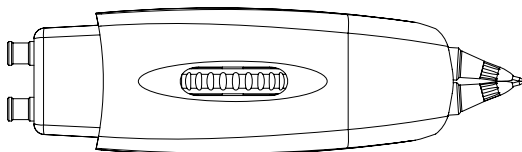

Figure 3 Hand-held Differential Probe Head

As shown in **Figure 4**, the probe tip is a standard accessory and replaceable. If it is damaged during use, you can easily replace it with a new one (refer to **To Replace Probe Accessories**).

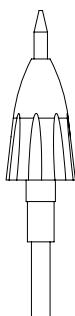

Figure 4 Probe Tip

## 2. Solder-in Probe Head

The solder-in probe head includes two types: **solder-in differential probe head** and **solder-in single-ended probe head**, as shown in **Figure 5** and **Figure 6**. Wherein, solder-in differential probe head is suitable for measurement of high-density IC pin signals.

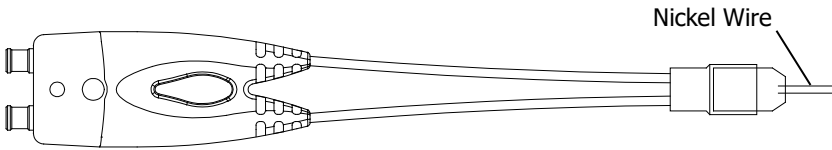

Figure 5 Solder-in Differential Probe Head

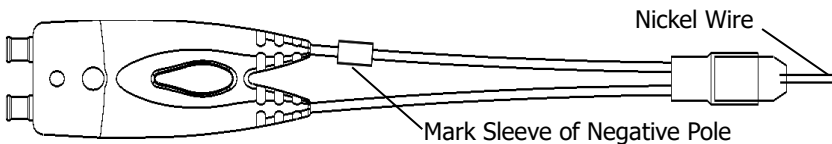

Figure 6 Solder-in Single-ended Probe Head

When using the solder-in probe head for measurement, please use an auxiliary device to fix the probe head. Do not use your hand to fix the probe head, or else, the lead resistor soldered onto the probe head might break or fall off. What's more, the hand-held position might also affect the probe performance.

The nickel wire of the solder-in probe head is a standard accessory. If the nickel wire under use is damaged or broken, please replace it with an appropriate lead resistor (refer to **To Replace Probe Accessories**).

# To Use PVA7000 Series Active Probe

During the use of PVA7000 series active probe, correct operations can ensure the probe performance, prolong the service life of the probe and ensure the effectiveness of the signal measurement result. This chapter introduces in detail the using method of the PVA7000 series active probe.

## Main Topics:

- To Connect to the Oscilloscope
- To Use the Probe Head
- To Replace Probe Accessories
- To Adjust Offset Voltage
- To Calibrate the Probe

## To Connect to the Oscilloscope

After PVA7000 is connected correctly to a **RIGOL** MSO8000 series oscilloscope, the oscilloscope recognizes the probe automatically and provides both power and offset voltage to the probe. You can adjust the offset voltage (refer to **To Adjust Offset Voltage**) and calibrate the probe (refer to **To Calibrate the Probe**) by the front panel menu of the oscilloscope.

Please connect the probe to the oscilloscope following the steps below:

1. Connect the probe head (in the figure, taking a hand-held differential probe head for example) with the active probe amplifier. If a single-ended probe head is used, during the connection, pay attention to their polarities.

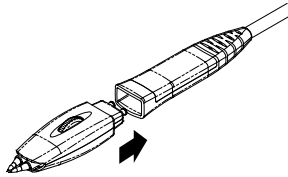

2. Connect the other end of the active probe amplifier to the channel input connector of the oscilloscope and make sure the connection is tight.

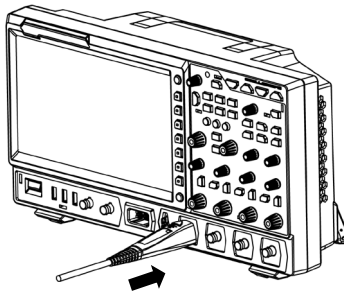

3. Use any probe auxiliary device to connect the probe to the circuit to be tested.



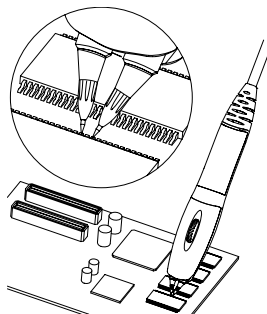

4. To disconnect the probe from the oscilloscope, press the button on the probe (as shown in the left figure below), pull the connector straight out of the oscilloscope (as shown in the right figure below) and then release the button.

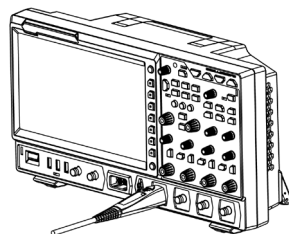
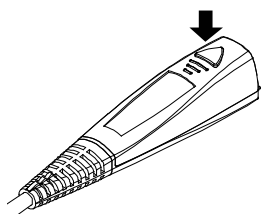
**CAUTION**

Do not twist the probe on the BNC connector of the oscilloscope. Otherwise, the probe might be damaged.

## To Use the Probe Head

In the **Probe Head** section, PVA7000 can be connected to 3 kinds of probe heads. You can easily change the probe head by using the method introduced in **To Replace Probe Accessories**. This chapter introduces how to use these three kinds of probe heads respectively.

### 1. Hand-held Differential Probe Head

The hand-held differential probe head provides an effective bandwidth of more than 2.5 GHz. The spacing between the two probe tips can be precisely adjusted by turning the roller. The probe tips are replaceable, which can prolong the service life of the probe.

The hand-held differential probe head can be used to measure differential and single-ended signals. During the measurement, you can turn the roller on the probe head to adjust the spacing between the probe tips to fit measurements with different spacing requirements.

The structure of the hand-held differential probe head is shown in **Figure 7**.

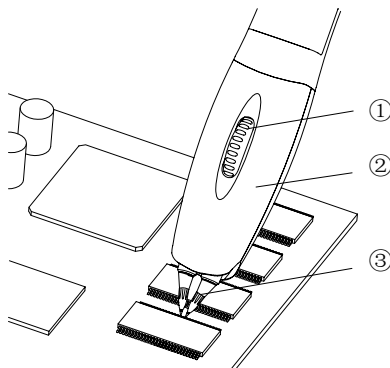

Figure 7 Hand-held Differential Probe Head

- ① Turning the roller to adjust the spacing (2mm to 6.5mm) between the two probe tips.
- ② Hand-held differential probe head.
- ③ 50Ω probe tip.

## 2. Solder-in Differential Probe Head

The solder-in differential probe head provides an effective bandwidth of more than 2.5 GHz. The replacement of the nickel wire enhances the usability of the probe and prolongs its service life.

The structure of the solder-in differential probe head is shown in **Figure 8**.

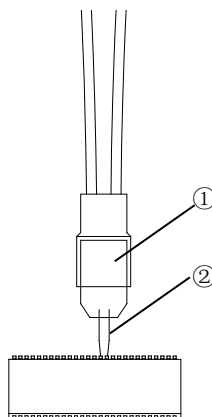

Figure 8 Solder-in Differential Probe Head

- ① Solder-in differential probe head.
- ② 0.2mm Nickel Wire.

When the points to be tested are widely spaced, the length of the nickel wire will be increased. At this point, overshoot and ringing will occur and the high-frequency response will change.

### 3. Solder-in Single-ended Probe Head

The solder-in single-ended probe head provides an effective bandwidth of more than 2.5 GHz. The replacement of the nickel wire enhances the usability of the probe and prolongs its service life.

The structure of the solder-in single-ended probe head is shown in **Figure 9**.

The pin at the same side with the negative pole mark sleeve (refer to **Figure 6**) is negative.

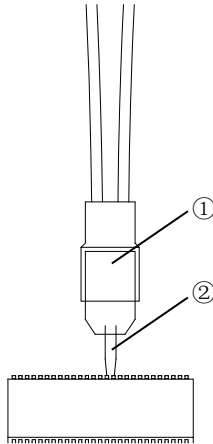

Figure 9 Solder-in Single-ended Probe Head

- ① Solder-in single-ended probe head.
- ② 0.2mm Nickel Wire.

When the points to be tested are widely spaced, the length of the nickel wire will be increased. At this point, overshoot and ringing will occur and the high-frequency response will change.

## To Replace Probe Accessories

### 1. To replace the probe head

Take care not to damage the connecting part to avoid affecting the probe performance when replacing the probe head.

Replacing Method:

- ① Disconnect the current probe head from the active probe amplifier.
- ② Push the new probe head into the active probe amplifier straightly.  
When single-ended probe head is used, pay attention to their polarities.

### 2. To replace the probe tip

The probe tip and probe head are connected to the screw thread, so please note the screw rotation and strength when removing and installing the probe tip.

### 3. To replace the nickel wire

If the nickel wire of the solder-in probe head under use becomes damaged or breaks off, you can replace a new one. The probe head nickel wire should satisfy the following size requirement, that is, the length must be shorter than 5 mm.

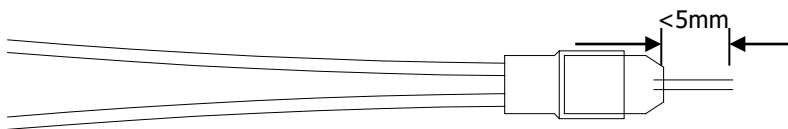

Note: If the length of the nickel wire is longer than 5 mm, the bandwidth specification of the probe will be affected. You can use the trim gauge to measure and cut the nickel wire.

## To Adjust Offset Voltage

**RIGOL** MSO/DS7000/MSO8000 series oscilloscope can provide offset voltage to the PVA7000 series active probe. The offset voltage adjusts the measured signal which exceeds the input dynamic range of the probe to within an appropriate range to ensure the measured signal's integrity.

You can adjust the offset voltage by operating the front panel menu of the oscilloscope. The operation method is as shown below.

1. Follow the instructions in **To Connect to the Oscilloscope** to connect the PVA7000 series active probe to the channel input terminal (e.g. CH1) of the MSO/DS7000/MSO8000 oscilloscope.
2. Open the probe offset voltage control menu of the MSO/DS7000/MSO8000 oscilloscope (front panel operation: **1** → **Probe** → **Bias Voltage**) and rotate the knob to adjust the value.

---

## To Calibrate the Probe

Before using, you should calibrate the PVA7000 series active probe. Follow the procedures below to calibrate the PVA7000 active probe:

1. Connect the PVA7000 active probe to the analog channel (CH1 to CH4 of the oscilloscope, illustrations here are based on CH1).
2. Open the probe calibration control menu (front panel operation: **1** → **Probe** → **Probe-Cal**), and the oscilloscope starts to calibrate the probe. The calibration will last for about 40 to 50 seconds. When the probe calibration is finished, a prompt message "Probe calibration finished!" or "Probe calibration failure!" is displayed in the user interface of the oscilloscope.

Note: Technical specifications of the PVA7000 series active probe depend on the calibration operation. After the calibration is finished, the DC gain, offset voltage zero and offset gain will be calibrated. Users can query the information about the manufacturer, model, serial number, and the last calibration time of the probe through the menu operation: **1** → **Probe** → **Probe Info**.

# Care and Cleaning

## Care

Do not place the probe and its accessories in places where they will be exposed to sun light for long periods of time.



---

### CAUTION

Keep the probe and its accessories away from any corrosive liquid.

---

## Cleaning

Clean the probe and its accessories regularly according to their operation conditions using the method below.

1. Disconnect the probe from the oscilloscope or power source.
2. Clean the external surfaces of the probe and its accessories with a soft cloth dampened with mild detergent or water.



---

### WARNING

To avoid short-circuit resulting from moisture or even personal injuries, ensure that the probe is completely dry before use.

---



## Warranty

**RIGOL** TECHNOLOGIES CO., LTD. (hereinafter referred to as **RIGOL**) warrants that the product will be free from defects in materials and workmanship within the warranty period. If a product proves defective within the warranty period, **RIGOL** guarantees free replacement or repair for the defective product.

To get repair service, please contact with your nearest **RIGOL** sales or service office.

There is no other warranty, expressed or implied, except such as is expressly set forth herein or other applicable warranty card. There is no implied warranty of merchantability or fitness for a particular purpose. Under no circumstances shall **RIGOL** be liable for any consequential, indirect, ensuing, or special damages for any breach of warranty in any case.

# Specifications

## Technical Specifications

Item	PVA7250
Bandwidth	>2.5GHz
Rise Time	<140ps
System Bandwidth	2.5GHz
Input Capacitance	<1pF
Input Resistance	50kΩ±2% Differential 25kΩ±4% Single-ended
Input Dynamic Range	±2V
Input Common mode Range	±6.25V DC to 100Hz ±1.25V >100Hz
Common Mode Rejection Ratio	>45dB@1MHz
DC Attenuation	10:1 ±2%
Zero Offset Error <sup>[1]</sup>	<30mV before calibration <5mV after calibration
Offset Voltage Range	±2V
Offset Accuracy <sup>[1]</sup>	<3% of current range before calibration <1% of current range after calibration
Input Noise	3.8mVpp
Propagation Delay	7ns
Max Input Voltage	30V Peak CAT I <sup>[2]</sup>
Electrostatic Protection (HBM)	>8kV

## General Characteristics

<b>Environmental Conditions</b>	<b>Operating</b>	<b>Non-operating</b>
Temperature	+5°C to +40°C	-40°C to +60°C
Humidity	0 RH to 80% RH	0 RH to 90% RH
Altitude	4600m	15300m
Power Consumption	1.2W	N/A
Weights	147g±10g <sup>[3]</sup> 530g±50g <sup>[4]</sup>	
Wire Length	1.4m	

- [1] Typical value. The specifications would change when different scales are selected.
- [2] CAT I and CAT II Definitions  
 Installation Category (Overvoltage Category) I: signal level, special equipment or parts of equipment, telecommunication, electronic, etc., with smaller transient voltages than installation category (Overvoltage Category) II.  
 Installation Category (Overvoltage Category) II: local level, appliance, portable equipment etc., with smaller transient voltages than installation category (Overvoltage Category) III.
- [3] The weight of the PVA7000 probe with the hand-held differential probe head.
- [4] The weight of the PVA7000 series active probe kit with the probe bag.